

LED MAGIC DOOR KIT

Troffer Retrofit Kit



The LED Magic Door Kit is typically used to retrofit 2x2 and 2x4 fluorescent troffers. The LED Magic Door Kits are designed to retrofit troffers in drop ceilings in offices, schools, showrooms, airports, retail locations, and healthcare facilities. The Door Kit utilizes an ultra modern design with an industry leading 130 lumens per watt.



DIMENSIONS

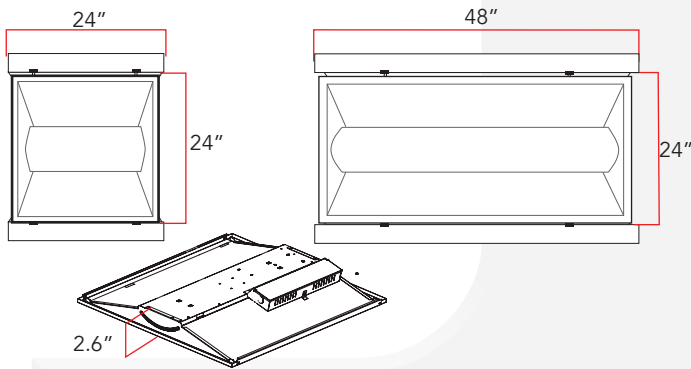

CERTIFICATIONS



FEATURES

- Quick installation in under five minutes
- External UL Listed Class-2 Constant Current Driver
- Comes with mounting brackets
- Suitable for damp locations
- Minimize labor and recycling costs
- Ease of installation and maintenance
- 0-10V Dimming
- 5 Year Manufacturer's Warranty

COMMON TECHNICAL DATA

Color Temperature	3000K to 5000K
Beam Angle	120 Degrees
CRI	> 80
Operation Temperature	-30°C to 40°C
Efficiency	More than 130 LPW
Input Voltage	100-277VAC, *382V Available
Input Frequency	50/60Hz
Power Factor	More than 0.99
Rated Life	100,000 hours
LED Type	SMD 2835
Housing	Aluminum
Dimming	0-10V

WARRANTY

This product has a warranty for a period of 5 years from the date of purchase. The warranty is invalid in the case of improper installation, tampering, or removal of the Q.C. date label. Installation in an improper working environment or installation not according to the current edition of the National Electric Code also invalidates the warranty. Should this product fail during the warranty period, it will be replaced free of charge, subject to correct installation and return of the faulty unit. JL Lighting does not accept responsibility for any installation costs associated with the replacement of this product. This warranty is in addition to the statutory rights in the country of purchase. JL Lighting reserves the right to alter specifications without prior notice.

PRODUCT SPECIFICATION

Product Number	Length (FT)	Wattage	Color	Lumens	Dimmable	Voltage	QTY/CTN
ZY-R4-25W XDZ	2'x2'	25W	4000K/5000K	3365	0-10V	AC100-277V/AC100-382V	2pcs/CTN
ZY-R4-36W XDZ	2'x2'	36W	4000K/5000K	5031	0-10V	AC100-277V/AC100-382V	2pcs/CTN
ZY-R7-25W XDZ	2'x4'	25W	4000K/5000K	3365	0-10V	AC100-277V/AC100-382V	2pcs/CTN
ZY-R7-36W XDZ	2'x4'	36W	4000K/5000K	4929	0-10V	AC100-277V/AC100-382V	2pcs/CTN
ZY-R7-50W XDZ	2'x4'	50W	4000K/5000K	6363	0-10V	AC100-277V/AC100-382V	2pcs/CTN

ORDERING GUIDE

ZY Company Code	R4/R7 Size	25W/36W/50W Wattage	XDZ Dimming	4000K/5000K CCT
--------------------	---------------	------------------------	----------------	--------------------

INSTALLATION INSTRUCTIONS

Retrofit Procedure:

1. Turn OFF power to the fixture at the breaker panel before installation.
2. Open the diffuser from the light fixture.
3. Remove the fluorescent tubes and dispose of these properly as they may contain mercury.
4. Remove the ballast cover and disconnect host fixture ballast from main.
5. Remove existing lamps, door frame (if applicable), reflector and ballast cover. Depending on clearance space, ballast may need to be removed.
6. Slide in both mounting brackets between the housing and the T-grid (A).
7. Hang the retrofit kit body by hooking the T-hinges into the slots and attach the safety cables to the opposing bracket (B).
8. Connect AC wires and/or dimming wires (C).
9. Close door kit pushing it up and securing the bracket with the latches.
10. Switch ON power to the fixture at the breaker panel

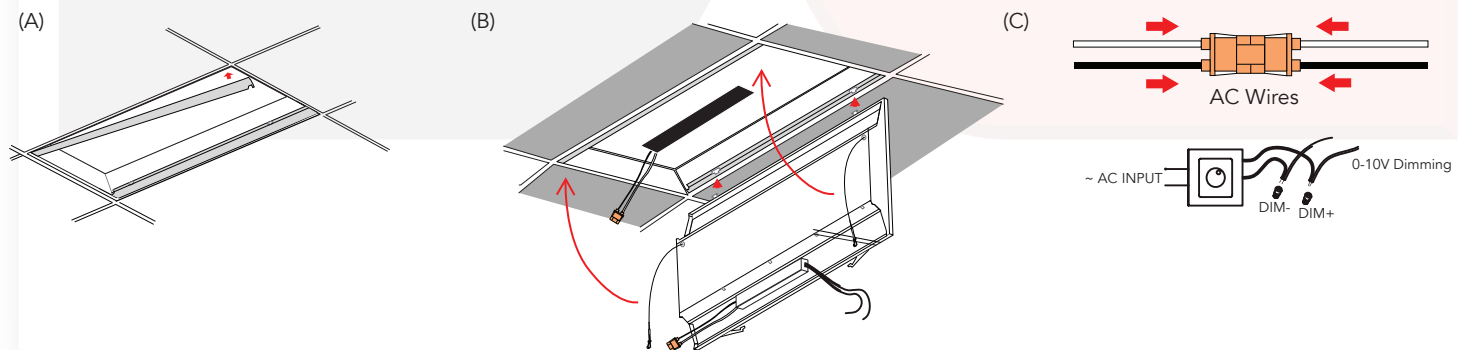

CAUTION

- Risk of fire- do not install this lamp in a pre-heated luminaire.
- Risk of electric shock- make installation with gloves.
- Access above ceiling required. DO NOT cover fixture with insulation liner or similar material.
- These lamps are to be used with a light dimmer.
- If the lamp or luminaire exhibits undesirable operation (i.e. buzzing, flickering, etc.), immediately turn off power and remove the lamp from luminaire and contact manufacturer.
- Do not make mass installation before sample testing.